

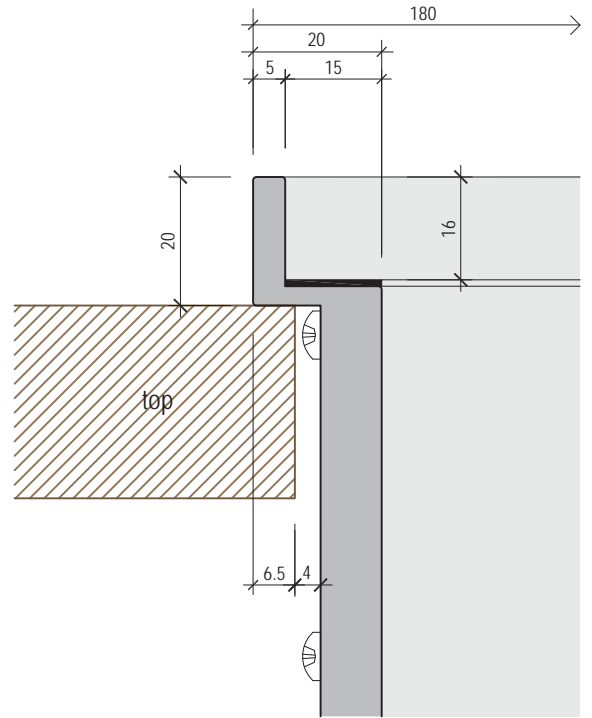

EASyrACK KITCHEN

STEP 1950 appoggio sul top* / STEP 1950 standing on the top*

*almeno 3 lati o 2 contrapposti / *at least 3 sides or 2 opposite sides

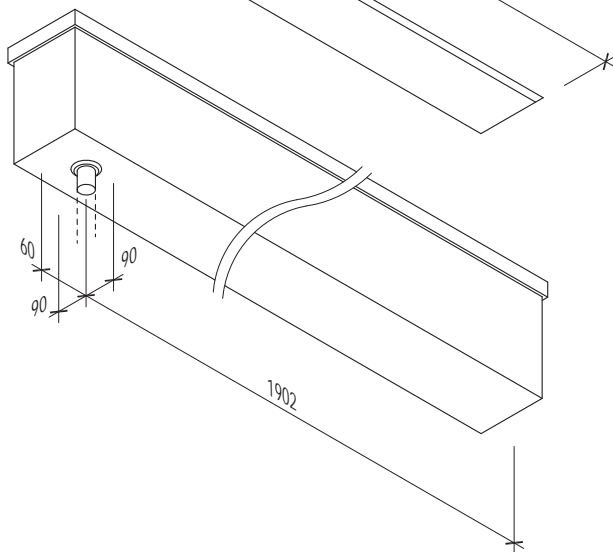
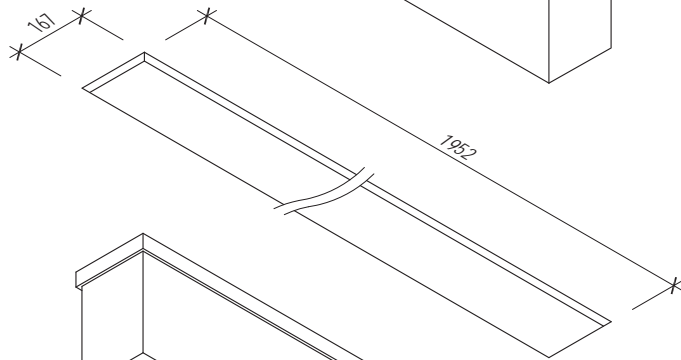
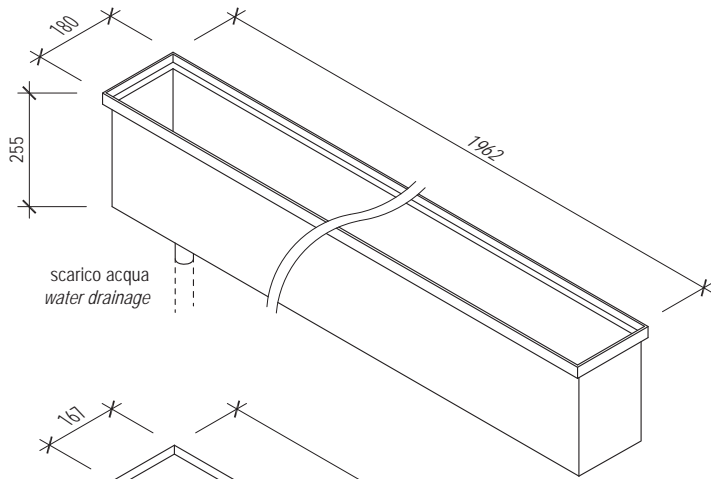

sezione del bordo / frame section

vista superiore / top view

foro nel top / hole in the top

vista inferiore / bottom view