

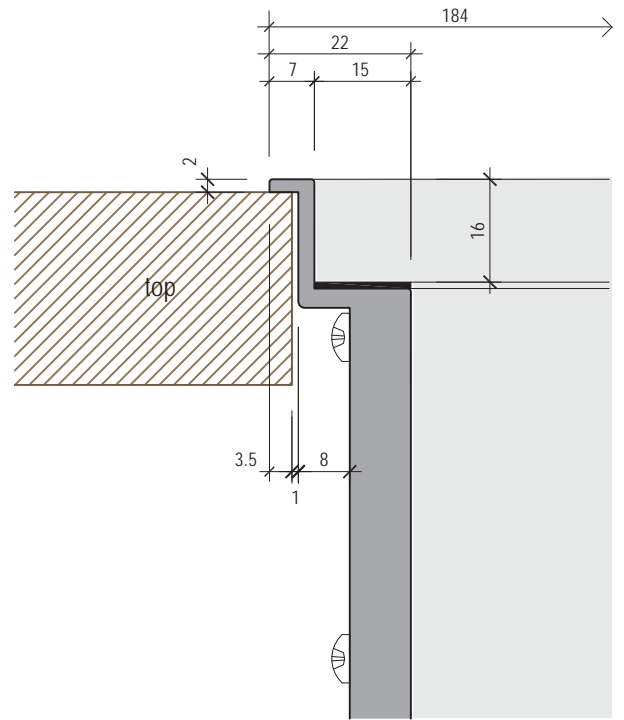

EASYRACK KITCHEN

FLAT 3000 appoggio sul top* / FLAT 3000 standing on the top*

*almeno 3 lati o 2 contrapposti / *at least 3 sides or 2 opposite sides



sezione del bordo / frame section

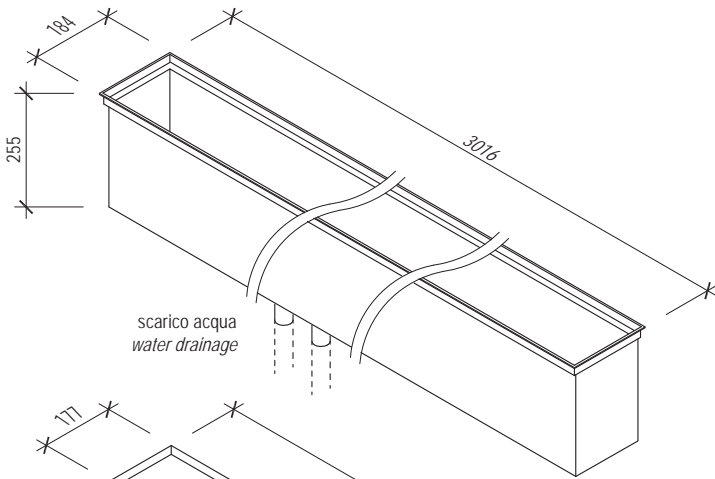

vista superiore / top view

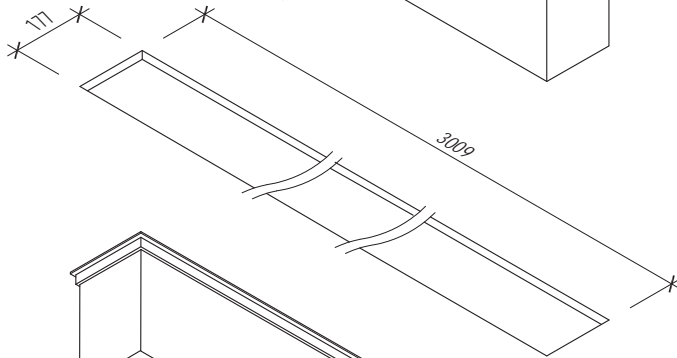

foro nel top / hole in the top

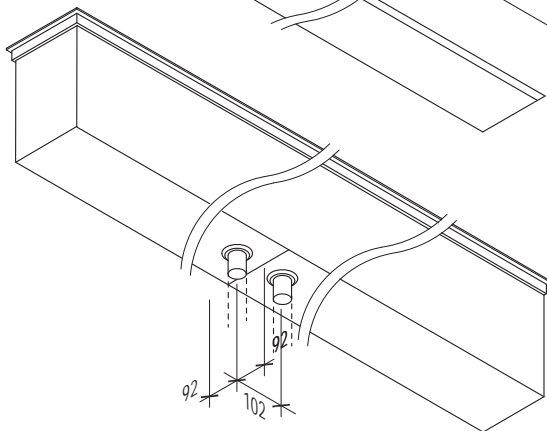

vista inferiore / bottom view